

Constant current independent dimmable driver
DEL Series suffix d(DALI-2+pushDIM)



Features

- Support DALI-2+pushDIM dimming mode
- 10-level current output can be realized by DIP-switch
- Soft dimming and flicker-free at any brightness
- Using HPC patented technology, at any dimming level, the brightness of the lights is the same
- Dimming range 1~100%, output current accuracy 2%
- Standby power input<0.5W, meets the requirements of ErP certification
- High PF, high efficiency, low THD
- Screw-free and pressing type strain relief, supports thicker cables and is easier to install
- Independent input and output strain relief, stronger wiring
- Intelligent LED hot-plug protection function
- SELV and Class II design, suitable for use inside of the light
- Passed CE,ENEC,UKCA,RCM,CCC,DALI-2 and other certifications
- IP20 protection grade, indoor use
- Nominal life-time up to 100,000 h
- 5-year guarantee

Interfaces

- DALI-2(DALI-2 DT6)
- PUSH(pushDIM)

Functions

- Support central emergency application (dimming normal in DC input)
- Support self-contained emergency application
- Protective features (short-circuit, overload,no-load, hot plug-in protection)

Suitable for lights

- Suitable for lights with independent drivers such as downlights, spotlights, panel lights, etc
- Not suitable for lights with built-in drivers

Typical applications

- LED indoor lighting
- LED office lighting
- LED commercial lighting



Model coding rules of DEL series

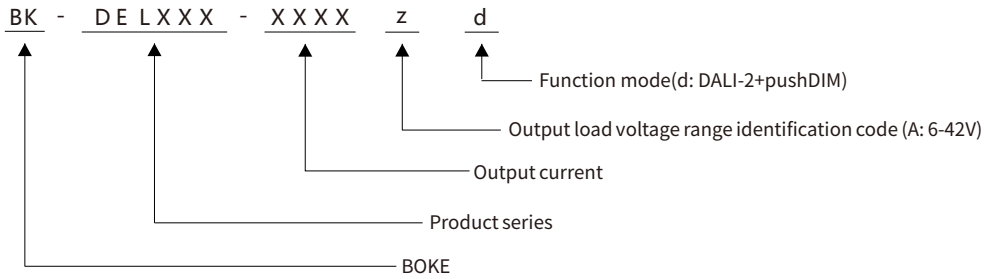

Function list

Model	suffix	Wired dimming		Advanced functions
		DALI-2	pushDIM	EL
BK-DEL010 BK-DEL022 BK-DEL028 BK-DEL030 BK-DEL042 BK-DEL060	d	√	√	√

* The description in this specification is only applicable to the products with the suffix d and the model are DEL010,DEL022 and DEL028. .

Model list

Model	Input voltage	Output power	Output voltage	Output current	Dimension	Certifications
BK-DEL010-0350Ad	200-240VAC	10W	6-30/36/40/42VDC	0.10-0.35A	L117*W45.5*H24mm	CE, ENEC, UKCA, RCM, CCC, EL, DALI-2
BK-DEL022-0600Ad	200-240VAC	22W	6-38/42VDC	0.225-0.60A	L117*W45.5*H29mm	CE, ENEC, UKCA, RCM, CCC, EL, DALI-2
BK-DEL028-0750Ad	200-240VAC	28W	6-38/40/42VDC	0.30-0.75A	L117*W45.5*H29mm	CE, ENEC, UKCA, RCM, CCC, EL, DALI-2
BK-DEL030-0800Ad	200-240VAC	30W	6-38/40/42VDC	0.25-0.80A	L103*W68.5*H30.5mm	CE, ENEC, UKCA, RCM, CCC, EL, DALI-2
BK-DEL042-0800Bd	200-240VAC	42W	6-52/54/60/64/70/76/84VDC	0.25-0.80A	L103*W68.5*H30.5mm	CE, ENEC, UKCA, RCM, CCC, EL, DALI-2
BK-DEL042-1100Ad	200-240VAC	42W	6-38/40/42VDC	0.45-1.10A	L103*W68.5*H30.5mm	CE, ENEC, UKCA, RCM, CCC, EL, DALI-2
BK-DEL060-2000Ad	200-240VAC	60W	6-30/32/34/36/38/40/42VDC	0.80-2.00A	L123.5*W79.5*H31mm	CE, ENEC, UKCA, RCM, CCC, EL, DALI-2

* The description in this specification is only applicable to the products with the suffix d and the model are DEL010,DEL022 and DEL028. .

Technical data

Product model	BK-DEL010-0350Ad
Output parameters	
Regulation method	Constant Current
Rated output current	0.1-0.35A
Rated output voltage	6V - 30V/36V/40V/42V
Rated output power	10.5W Max
Output current adjustment	DIP S.W(10 levels)
Output current ripple LF	±2%
Output current accuracy	±2%
Linear regulation	±1%
Load regulation	±1%
No load output voltage	50V
Flicker-free(typical)	Modulation depth =2.413% (100Hz), Pst LM =0.052, SVM = 0.085,(The above parameters are obtained from testing the panel lights)
Input parameters	
Rated input voltage	200-240VAC 200-240VDC
Rated input voltage	180-264VAC 200-264VDC
Input voltage shock	<380 V AC, 1 h
Input current	<0.07A (AC input)
Input frequency	0/50/60Hz
Input power factor	0.95 (230V AC & Full load)
Input THD	10% (230V AC & Full load)
Efficiency(typical)	84% (230V AC & Full load)
In-rush current	4A peak ,160us duration(50 % Ipeak), see the description below for details
Start/Switchover/Turn off	<0.6s(AC start),<0.6s(DC start),<0.3s(AC/DC switchover),<0.5s(Turn off)
Switching cycles	> 50,000 switching cycles
Power consumption	Full load(Pmax):10.5W, No load(Pno): N/A, On stand-by(Psb) : <0.5W, Network stand-by(Pnet) : N/A
Safety	
Withstand voltage	I/P-O/P(LED):3750V AC, I/P-DALI: 1500V AC, O/P-DALI: 1500V AC.
Mains surge capability	L-N:2KV
Leakage current	<0.7mA (230V AC & Full load)
Isolation resistance	I/P-O/P:100MΩ/500Vdc/25°C/70% RH
Control interface	
DALI dimming port	Voltage range: 9.5-22.5V, typical 16V, interface current consumption: 1.8mA
pushDIM dimming port	Voltage range: 180-264V 47/63Hz
1-10V 3in1 dimming port	N/A
Auxiliary power supply	N/A
Dimming range	1-100%
Dimming drive mode	AM(amplitude modulation)
Emergency support	
Central emergency system	Supported(dimming normal in DC input)
Self-contained emergency	Supported
Environment & Life time	
Operating temperature	Ta=-20-60°C
Case temperature	Tc=90°C
Operating humidity	5-85% RH, not condensed
Storage temp./humidity	-40-80°C, 5-85% RH, not condensed
IP grade	IP20
MTBF	500,000H,MIL-HDBK-217F(25°C)
Life-time	Nominal life-time up to 100,000 h, see the description below for details
Vibration resistant	10~500Hz,5G 12min./1cycle,period for 72min. each along X,Y,Z axes
Acoustic Noise	<25dB(30cm, Full load)
Environmental protection	RoHS
Certifications and standards	
Certified	CE, ENEC, UKCA, RCM, CCC, EL, DALI-2
Safety	EN61347-1, EN61347-2-13, EN62384
EMC	EN55015, EN61000-3-2 , EN61000-3-3, EN61000-4-2,3,4,5,6,8,11, EN61547
DALI-2	IEC 62386-101(DALI-2), IEC 62386-102(DALI-2), IEC 62386-207(DALI-2)
EL	Compatible IEC 61347-2- 13 Annex J, compatible with EN 60598-2-22 and EN 50172
RF	N/A

Remarks

- 1.By default, all parameter are measured at 230VAC input, full load and 25°C of ambient temperature.
- 2.The driver can not be installed inside the light. when the driver is used with the light, the EMC of the whole light needs to be tested.

Technical data

Product model	BK-DEL022-0600Ad
Output parameters	
Regulation method	Constant Current
Rated output current	0.225-0.6A
Rated output voltage	6V - 38V/42V
Rated output power	22.8W Max
Output current adjustment	DIP S.W(10 levels)
Output current ripple LF	±2%
Output current accuracy	±2%
Linear regulation	±1%
Load regulation	±1%
No load output voltage	50V
Flicker-free(typical)	Modulation depth =0.363% (100Hz), Pst LM = 0.006, SVM = 0.010,(The above parameters are obtained from testing the panel lights)
Input parameters	
Rated input voltage	200-240VAC 200-240VDC
Rated input voltage	180-264VAC 200-264VDC
Input voltage shock	<380 V AC, 1 h
Input current	<0.14A (AC input)
Input frequency	0/50/60Hz
Input power factor	0.95 (230V AC & Full load)
Input THD	10% (230V AC & Full load)
Efficiency(typical)	86% (230V AC & Full load)
In-rush current	6.5A peak ,192us duration(50 % Ipeak), see the description below for details
Start/Switchover/Turn off	<0.6s(AC start),<0.6s(DC start),<0.3s(AC/DC switchover),<0.5s(Turn off)
Switching cycles	> 50,000 switching cycles
Power consumption	Full load(Pmax):22.8W, No load(Pno): N/A, On stand-by(Psb) : <0.5W, Network stand-by(Pnet) : N/A
Safety	
Withstand voltage	I/P-O/P(LED):3750V AC, I/P-DALI: 1500V AC, O/P-DALI: 1500V AC.
Mains surge capability	L-N:2KV
Leakage current	<0.7mA (230V AC & Full load)
Isolation resistance	I/P-O/P:100MΩ/500Vdc/25°C/70% RH
Control interface	
DALI dimming port	Voltage range: 9.5-22.5V, typical 16V, interface current consumption: 1.8mA
pushDIM dimming port	Voltage range: 180-264V 47/63Hz
1-10V 3in1 dimming port	N/A
Auxiliary power supply	N/A
Dimming range	1-100%
Dimming drive mode	AM(amplitude modulation)
Emergency support	
Central emergency system	Supported(dimming normal in DC input)
Self-contained emergency	Supported
Environment & Life time	
Operating temperature	Ta=-20-50°C
Case temperature	Tc=90°C
Operating humidity	5-85% RH, not condensed
Storage temp./humidity	-40-80°C, 5-85% RH, not condensed
IP grade	IP20
MTBF	500,000H,MIL-HDBK-217F(25°C)
Life-time	Nominal life-time up to 100,000 h, see the description below for details
Vibration resistant	10~500Hz,5G 12min./1cycle,period for 72min. each along X,Y,Z axes
Acoustic Noise	<25dB(30cm, Full load)
Environmental protection	RoHS
Certifications and standards	
Certified	CE, ENEC, UKCA, RCM, CCC, EL, DALI-2
Safety	EN61347-1, EN61347-2-13, EN62384
EMC	EN55015, EN61000-3-2, EN61000-3-3, EN61000-4-2,3,4,5,6,8,11, EN61547
DALI-2	IEC 62386-101(DALI-2), IEC 62386-102(DALI-2), IEC 62386-207(DALI-2)
EL	Compatible IEC 61347-2- 13 Annex J, compatible with EN 60598-2-22 and EN 50172
RF	N/A

Remarks

- By default, all parameter are measured at 230VAC input, full load and 25°C of ambient temperature.
- The driver can not be installed inside the light. when the driver is used with the light, the EMC of the whole light needs to be tested.

Technical data

Product model	BK-DEL028-0750Ad
Output parameters	
Regulation method	Constant Current
Rated output current	0.3-0.75A
Rated output voltage	6V - 38V/40V/42V
Rated output power	28.5W Max
Output current adjustment	DIP S.W(10 levels)
Output current ripple LF	±2%
Output current accuracy	±2%
Linear regulation	±1%
Load regulation	±1%
No load output voltage	50V
Flicker-free(typical)	Modulation depth =0.508% (100Hz), Pst LM = 0.005, SVM = 0.010,(The above parameters are obtained from testing the panel lights)
Input parameters	
Rated input voltage	200-240VAC 200-240VDC
Rated input voltage	180-264VAC 200-264VDC
Input voltage shock	<380 V AC, 1 h
Input current	<0.18A (AC input)
Input frequency	0/50/60Hz
Input power factor	0.95 (230V AC & Full load)
Input THD	10% (230V AC & Full load)
Efficiency(typical)	86% (230V AC & Full load)
In-rush current	6.5A peak ,194us duration(50 % Ipeak), see the description below for details
Start/Switchover/Turn off	<0.6s(AC start),<0.6s(DC start),<0.3s(AC/DC switchover),<0.5s(Turn off)
Switching cycles	> 50,000 switching cycles
Power consumption	Full load(Pmax):28.5W, No load(Pno): N/A, On stand-by(Psb) : <0.5W, Network stand-by(Pnet) : N/A
Safety	
Withstand voltage	I/P-O/P(LED):3750V AC, I/P-DALI: 1500V AC, O/P-DALI: 1500V AC.
Mains surge capability	L-N:2KV
Leakage current	<0.7mA (230V AC & Full load)
Isolation resistance	I/P-O/P:100MΩ/500Vdc/25°C/70% RH
Control interface	
DALI dimming port	Voltage range: 9.5-22.5V, typical 16V, interface current consumption: 1.8mA
pushDIM dimming port	Voltage range: 180-264V 47/63Hz
1-10V 3in1 dimming port	N/A
Auxiliary power supply	N/A
Dimming range	1-100%
Dimming drive mode	AM(amplitude modulation)
Emergency support	
Central emergency system	Supported(dimming normal in DC input)
Self-contained emergency	Supported
Environment & Life time	
Operating temperature	Ta=-20-45°C
Case temperature	Tc=90°C
Operating humidity	5-85% RH, not condensed
Storage temp./humidity	-40-80°C, 5-85% RH, not condensed
IP grade	IP20
MTBF	500,000H,MIL-HDBK-217F(25°C)
Life-time	Nominal life-time up to 100,000 h, see the description below for details
Vibration resistant	10~500Hz,5G 12min./1cycle,period for 72min. each along X,Y,Z axes
Acoustic Noise	<25dB(30cm, Full load)
Environmental protection	RoHS
Certifications and standards	
Certified	CE, ENEC, UKCA, RCM, CCC, EL, DALI-2
Safety	EN61347-1, EN61347-2-13, EN62384
EMC	EN55015, EN61000-3-2 , EN61000-3-3, EN61000-4-2,3,4,5,6,8,11, EN61547
DALI-2	IEC 62386-101(DALI-2), IEC 62386-102(DALI-2), IEC 62386-207(DALI-2)
EL	Compatible IEC 61347-2- 13 Annex J, compatible with EN 60598-2-22 and EN 50172
RF	N/A

Remarks

- 1.By default, all parameter are measured at 230VAC input, full load and 25°C of ambient temperature.
- 2.The driver can not be installed inside the light. when the driver is used with the light, the EMC of the whole light needs to be tested.

Electrical values

BK-DEL010-0350Ad

Operating window

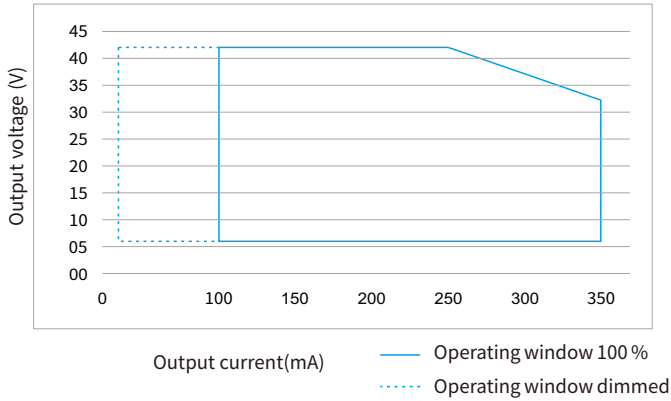

Operating window

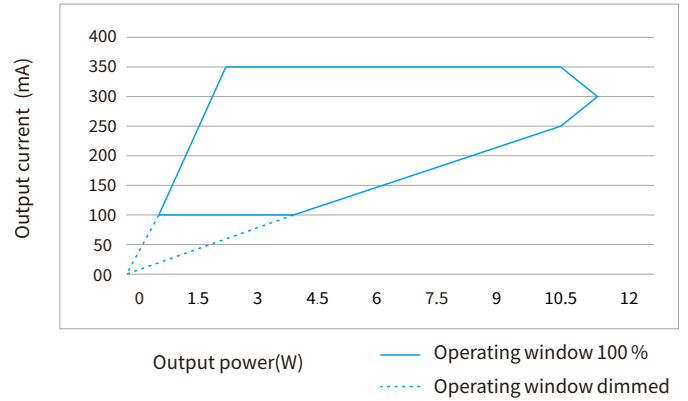

Efficiency vs load

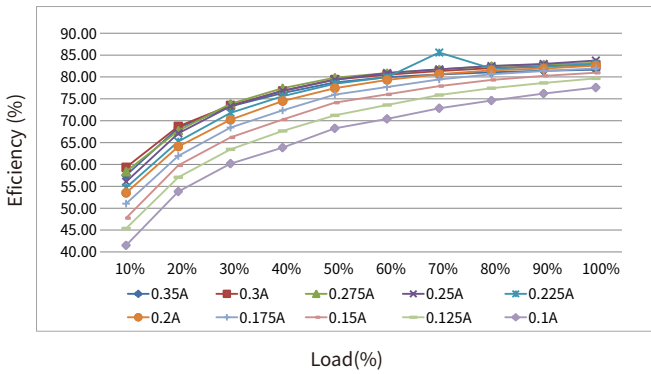

THD vs. Load

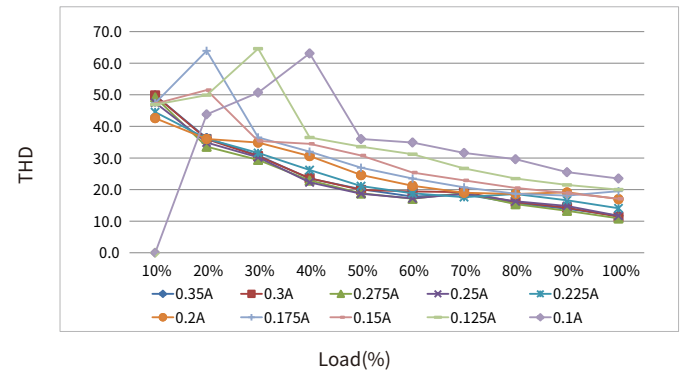

Power factor vs. Load

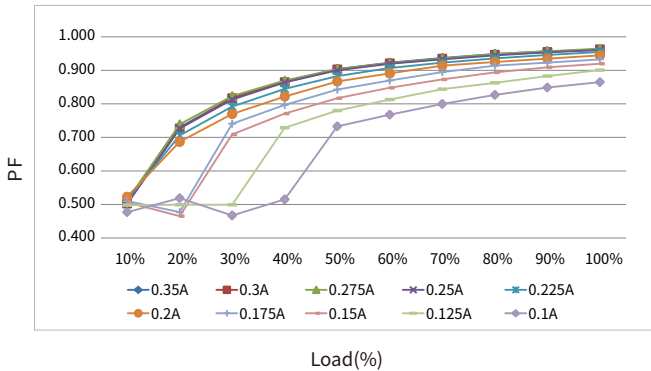

Expected life-time

Life-time vs. case temperature

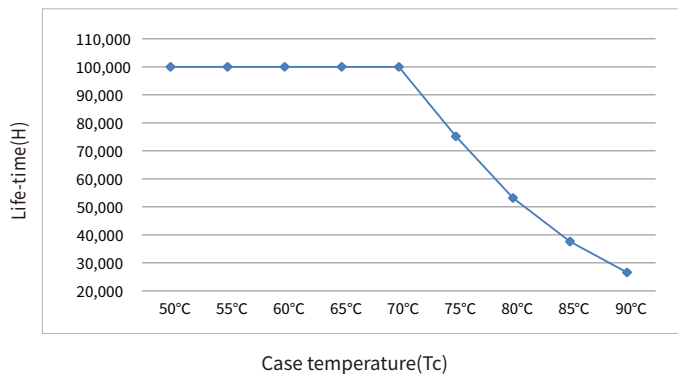

-The life-time of the LED driver is shown in the figure above (calculated based on the 90% survival rate).

- The relation of tc to ta temperature depends also on the luminaire design.

Electrical values

BK-DEL022-0600Ad

Operating window

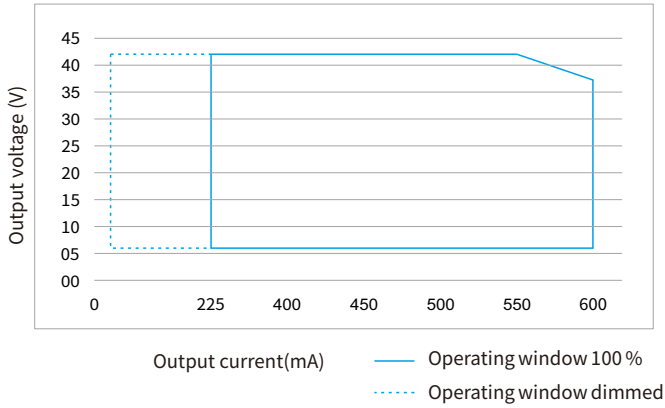

Operating window

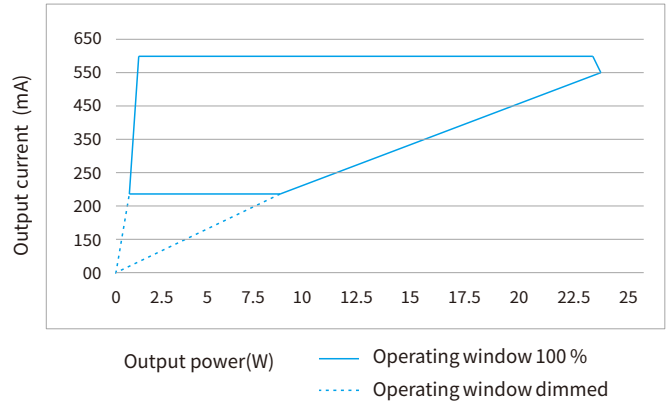

Efficiency vs load

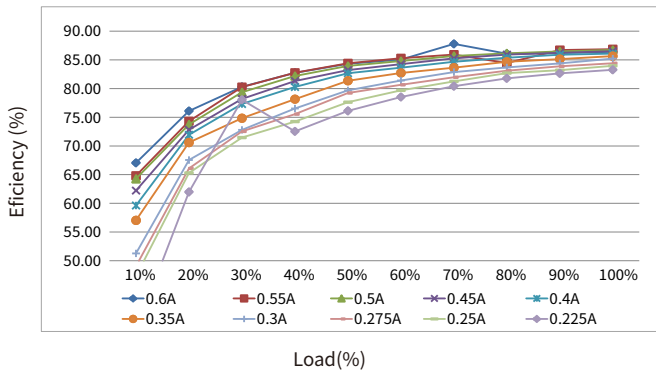

THD vs. Load

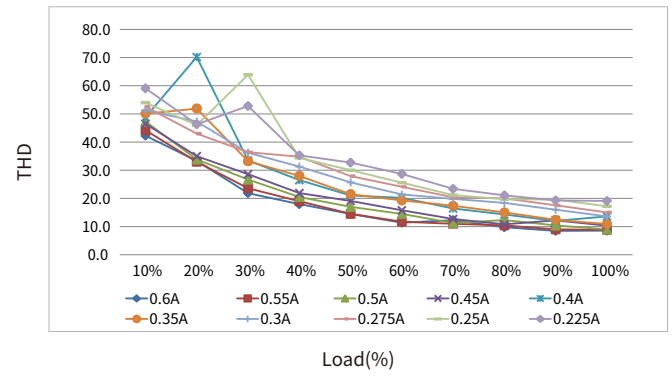

Power factor vs. Load

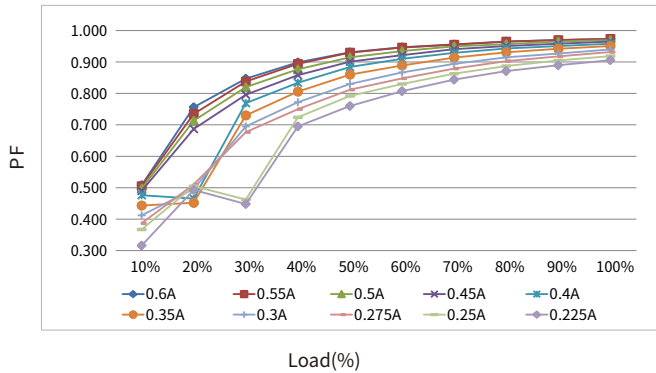

Expected life-time

Life-time vs. case temperature

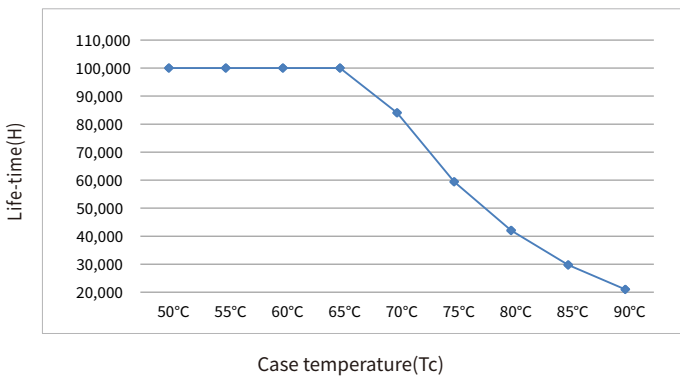

-The life-time of the LED driver is shown in the figure above (calculated based on the 90% survival rate).
 - The relation of tc to ta temperature depends also on the luminaire design.

Electrical values

BK-DEL028-0750Ad

Operating window

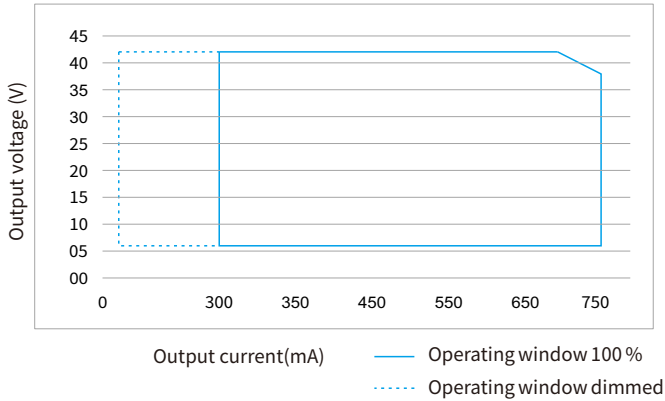

Operating window

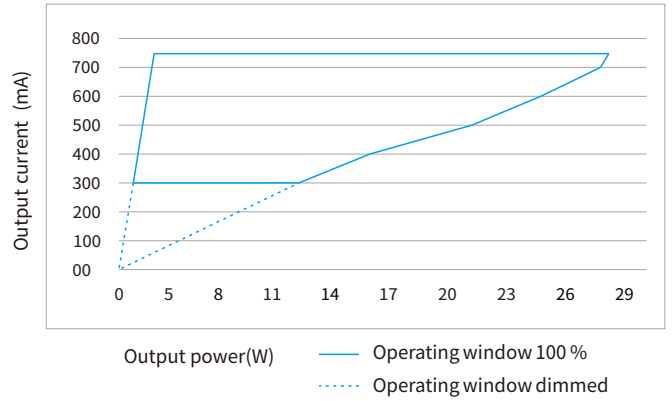

Efficiency vs load

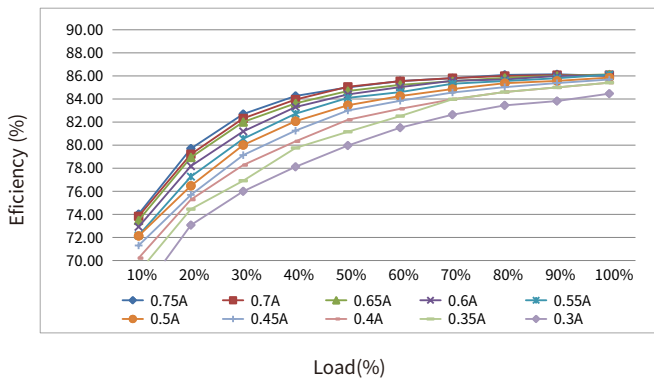

THD vs. Load

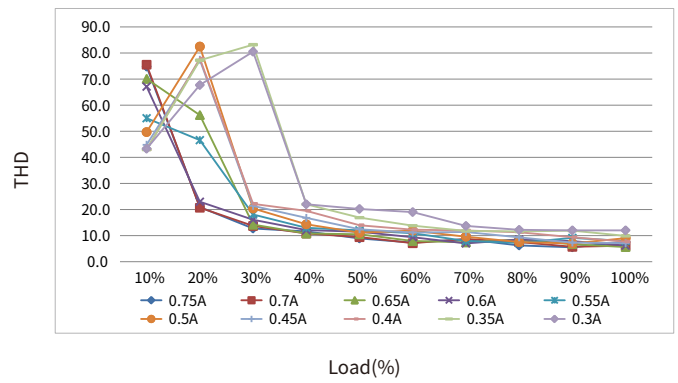

Power factor vs. Load

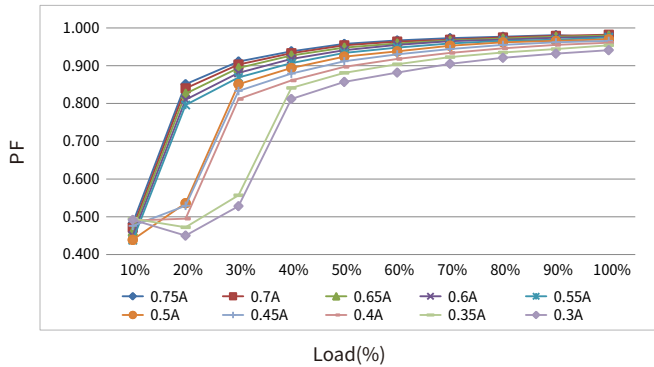

Expected life-time

Life-time vs. case temperature

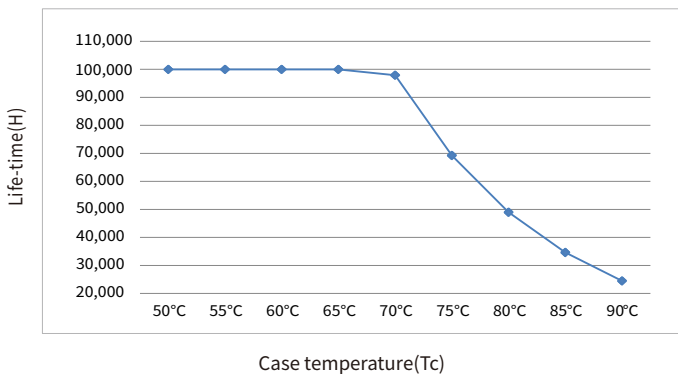

-The life-time of the LED driver is shown in the figure above (calculated based on the 90% survival rate).
 - The relation of tc to ta temperature depends also on the luminaire design.

Surge

Model	Ipeak	Twidth	Condition	Relative number of MCB														
				B10	B13	B16	B20	B25	C10	C13	C16	C20	C25	D10	D13	D16	D20	D25
BK-DEL010-0350Ad	4A	160us	AC 230V, Full load, Cold start, $T_a \leq 30^\circ\text{C}$, MCB is not installed side by side	99pcs	128pcs	158pcs	197pcs	247pcs	125pcs	162pcs	200pcs	250pcs	312pcs	125pcs	162pcs	200pcs	250pcs	312pcs
BK-DEL022-0600Ad	6.5A	192us		65pcs	65pcs	80pcs	100pcs	124pcs	59pcs	77pcs	94pcs	118pcs	147pcs	59pcs	77pcs	94pcs	118pcs	147pcs
BK-DEL028-0750Ad	6.5A	194us		48pcs	62pcs	77pcs	96pcs	120pcs	48pcs	62pcs	77pcs	96pcs	120pcs	48pcs	62pcs	77pcs	96pcs	120pcs

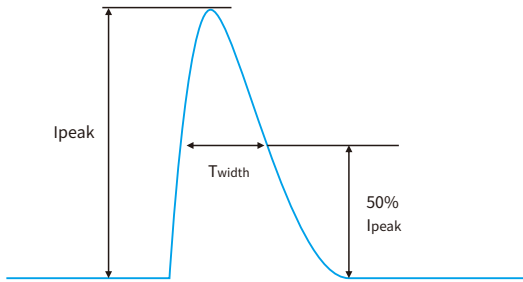

Remarks

- The number of drives mounted under different MCBs in the table is the maximum value. Please do not exceed this number during installation.
- Calculation uses typical values from ABB series S200 as a reference.
- Different brands and models of miniature circuit breakers, the number of drives mounted will be slightly different.
- If the ambient temperature of the MCB installation exceeds 30°C or multiple MCBs are installed side by side, the number of drives mounted will be reduced and the calculation needs to be recalculated.
- Electrician's usually consider Type B for household lighting and Type C for commercial lighting application.

Functions

Output short-circuit behaviour

- In case of a short-circuit at the LED output, the LED output is switched off.
- After restart of the LED driver, the output will be activated again.

Output no-load operation

- The LED driver will not be damaged in no-load operation.
- The output will be deactivated and is therefore free of voltage.
- If a LED load is connected, the device has to be restarted before the output will be activated again.

Output overload protection

- If the output voltage range is exceeded the LED driver turns off the LED output.
- After restart of the LED driver the output will be activated again.

Output hot plug-in

In the following two cases, the LED driver will automatically turn off the output to protect the LED

- When the driver is powered on first and the LED is connected later.
- When the driver is powered on, disconnected and connected again.
- After restart of the LED driver the output will be activated again.

Driver restart method

There are two ways to restart the device:

- Through the AC input port: disconnect the AC of the driver and power it again.
- Through dimming interface.

DALI: send "OFF" command first, then send "MAX" command.

pushDIM: short press PUSH switch two times, then long press PUSH switch.

Label
BK-DEL010-0350Ad

BOKE Dimmable Constant Current LED Driver P E Z L
MODEL: BK-DEL010-0350Ad
 INPUT: 200-240V \approx 0/50/60Hz 0.07A Max. λ : 0.95
 OUTPUT: 6-30V \approx 350mA 10.5W 50VDC Max. MADE IN CHINA
 Other ratings see selection sheet
 For LED Modules use only
 www.bokedriver.com

wire prep. 0.75-1.5mm² Preparation for input and output tc:90°C ta:60°C
 ■ ACL/DC+ 8-9mm ■ ACN/DC- ■ DA DA L N pushDIM

For Australia and New Zealand, the marking "label with"

Pin(W) typ.		Output		Switch			
Prated(w)	Irated(mA)	Voltage(Vdc)	1	2	3	4	
4.20	100	6-42	1	ON	ON	ON	
5.25	125	6-42	ON	ON	ON	ON	
6.30	150	6-42	ON	ON	ON	ON	
7.35	175	6-42	ON	ON	ON	ON	
8.40	200	6-42	ON	ON	ON	ON	
9.45	225	6-42	ON	ON	ON	ON	
10.5	250	6-42	ON	ON	ON	ON	
11.6	275	6-42	ON	ON	ON	ON	
12.8	300	6-36	ON	ON	ON	ON	
13.9	325	6-30	ON	ON	ON	ON	

Do not energize the driver before connecting the LED.

BK-DEL022-0600Ad

BOKE Dimmable Constant Current LED Driver P E Z L
MODEL: BK-DEL022-0600Ad
 INPUT: 200-240V \approx 0/50/60Hz 0.14A Max. λ : 0.95
 OUTPUT: 6-38V \approx 600mA 22.8W 50VDC Max. MADE IN CHINA
 Other ratings see selection sheet
 For LED Modules use only
 www.bokedriver.com

wire prep. 0.75-1.5mm² Preparation for input and output tc:90°C ta:50°C
 ■ ACL/DC+ 8-9mm ■ ACN/DC- ■ DA DA L N pushDIM

For Australia and New Zealand, the marking "label with"

Pin(W) typ.		Output		Switch			
Prated(w)	Irated(mA)	Voltage(Vdc)	1	2	3	4	
9.45	225	6-42	ON	ON	ON	ON	
10.50	250	6-42	ON	ON	ON	ON	
11.55	275	6-42	ON	ON	ON	ON	
12.60	300	6-42	ON	ON	ON	ON	
13.70	325	6-42	ON	ON	ON	ON	
14.80	350	6-42	ON	ON	ON	ON	
15.90	375	6-42	ON	ON	ON	ON	
17.00	400	6-42	ON	ON	ON	ON	
18.10	425	6-42	ON	ON	ON	ON	
19.20	450	6-42	ON	ON	ON	ON	
20.30	475	6-42	ON	ON	ON	ON	
21.40	500	6-42	ON	ON	ON	ON	
22.50	525	6-42	ON	ON	ON	ON	
23.60	550	6-42	ON	ON	ON	ON	
24.70	575	6-42	ON	ON	ON	ON	
25.80	600	6-38	ON	ON	ON	ON	

Do not energize the driver before connecting the LED.

BK-DEL028-0750Ad

BOKE Dimmable Constant Current LED Driver P E Z L
MODEL: BK-DEL028-0750Ad
 INPUT: 200-240V \approx 0/50/60Hz 0.18A Max. λ : 0.95
 OUTPUT: 6-38V \approx 750mA 28.5W 50VDC Max. MADE IN CHINA
 Other ratings see selection sheet
 For LED Modules use only
 www.bokedriver.com

wire prep. 0.75-1.5mm² Preparation for input and output tc:90°C ta:45°C
 ■ ACL/DC+ 8-9mm ■ ACN/DC- ■ DA DA L N pushDIM

For Australia and New Zealand, the marking "label with"

Pin(W) typ.		Output		Switch			
Prated(w)	Irated(mA)	Voltage(Vdc)	1	2	3	4	
12.60	300	6-42	ON	ON	ON	ON	
14.70	350	6-42	ON	ON	ON	ON	
16.80	400	6-42	ON	ON	ON	ON	
18.90	450	6-42	ON	ON	ON	ON	
21.00	500	6-42	ON	ON	ON	ON	
23.10	550	6-42	ON	ON	ON	ON	
25.20	600	6-42	ON	ON	ON	ON	
27.30	650	6-42	ON	ON	ON	ON	
29.40	700	6-40	ON	ON	ON	ON	
31.50	750	6-38	ON	ON	ON	ON	

Do not energize the driver before connecting the LED.

DIP-switch & output current
BK-DEL010-0350Ad

Pin(W) typ.	Output			1	2	3	4
	Prated(w)	Irated(mA)	Voltage(Vdc)				
6.80	4.20	100	6-42	--	ON	ON	ON
8.30	5.25	125	6-42	ON	--	ON	ON
9.80	6.30	150	6-42	--	--	ON	ON
11.3	7.35	175	6-42	--	ON	--	ON
12.9	8.40	200	6-42	--	--	--	ON
12.9	9.45	225	6-42	ON	ON	ON	--
13.2	10.5	250	6-42	--	--	ON	--
13.3	11.0	275	6-40	--	ON	--	--
13.1	10.8	300	6-36	ON	--	--	--
12.8	10.5	350 ★	6-30	--	--	--	--

BK-DEL022-0600Ad

Pin(W) typ.	Output			1	2	3	4
	Prated(w)	Irated(mA)	Voltage(Vdc)				
11.2	9.45	225	6-42	--	ON	ON	ON
12.3	10.50	250	6-42	ON	--	ON	ON
13.5	11.55	275	6-42	--	--	ON	ON
14.6	12.60	300	6-42	--	ON	--	ON
16.9	14.70	350	6-42	--	--	--	ON
19.3	16.80	400	6-42	ON	ON	ON	--
21.6	18.90	450	6-42	--	--	ON	--
23.9	21.00	500	6-42	--	ON	--	--
26.6	23.10	550	6-42	ON	--	--	--
26.4	22.80	600 ★	6-38	--	--	--	--

BK-DEL028-0750Ad

Pin(W) typ.	Output			1	2	3	4
	Prated(w)	Irated(mA)	Voltage(Vdc)				
14.8	12.60	300	6-42	--	ON	ON	ON
17.0	14.70	350	6-42	ON	--	ON	ON
19.4	16.80	400	6-42	--	--	ON	ON
21.6	18.90	450	6-42	--	ON	--	ON
24.1	21.00	500	6-42	--	--	--	ON
26.9	23.10	550	6-42	ON	ON	ON	--
29.2	25.20	600	6-42	--	--	ON	--
31.8	27.30	650	6-42	--	ON	--	--
32.2	28.00	700	6-40	ON	--	--	--
33.4	28.50	750 ★	6-38	--	--	--	--

Remarks:

- ★ It means that this item is the factory default current.
- It means that this channel is OFF.

DALI dimming application

Wiring diagram

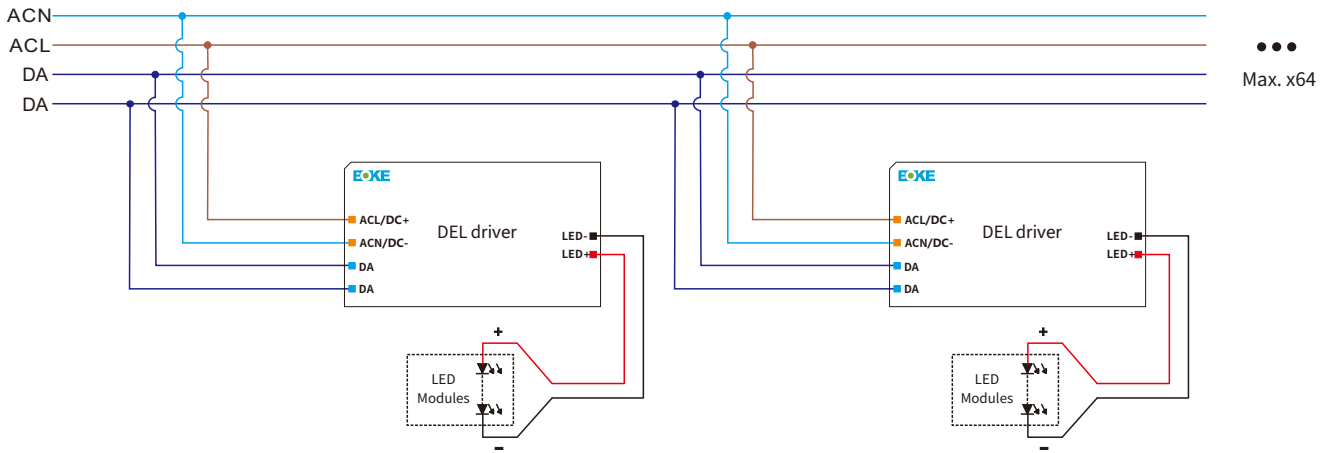

Activating DALI dimming mode

- After installation according to the wiring diagram of DALI dimming application, the driver will automatically switch to the DALI control mode after receiving any DALI command.

Remarks:

- Standard DALI control line voltage range: 9.5V to 22.5V, type 16V.
- The two DALI control lines polarity-reversible.
- Max. 64 DALI drivers per DALI control line.
- The maximum distance length of the DALI control line is 300m at $2 \times 1.5\text{mm}^2$.
- DALI bus can be wired together with any mains voltage cables, but separate wiring is recommended.
- The configuration parameters of the driver can be set through the DALI configuration tool or DALI application controller during installation, such as setting device address, group address, power-on level, bus-failure level, scene level, fade time, dimming curve, etc.

Please refer to the table below

Cable size	Distance
$2 \times 0.50\text{mm}^2$	max.100m
$2 \times 0.75\text{mm}^2$	max.150m
$2 \times 1.00\text{mm}^2$	max.200m
$\geq 2 \times 1.50\text{mm}^2$	max.300m

Power-on level :

When the driver is in DALI-2 dimming mode, the factory default level after each power-on is the brightest.

The power-on level can be set through the DALI configuration tool or DALI application controller during installation, and can be set to memory or fixed any brightness (such as off, darkest, 50%, etc.).

Note: The recommended setting for the default factory power-on level of the DALI-2 driver is the brightest in the DALI-2 standard.

Dimming curve

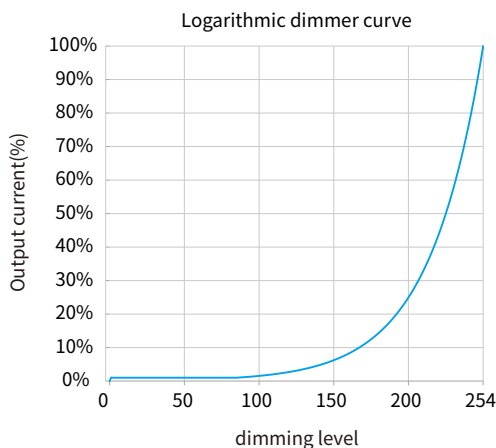

Remarks: The dimming curve can be selected by DALI configuration. The default is logarithmic dimming curve.

pushDIM dimming application

Wiring diagram

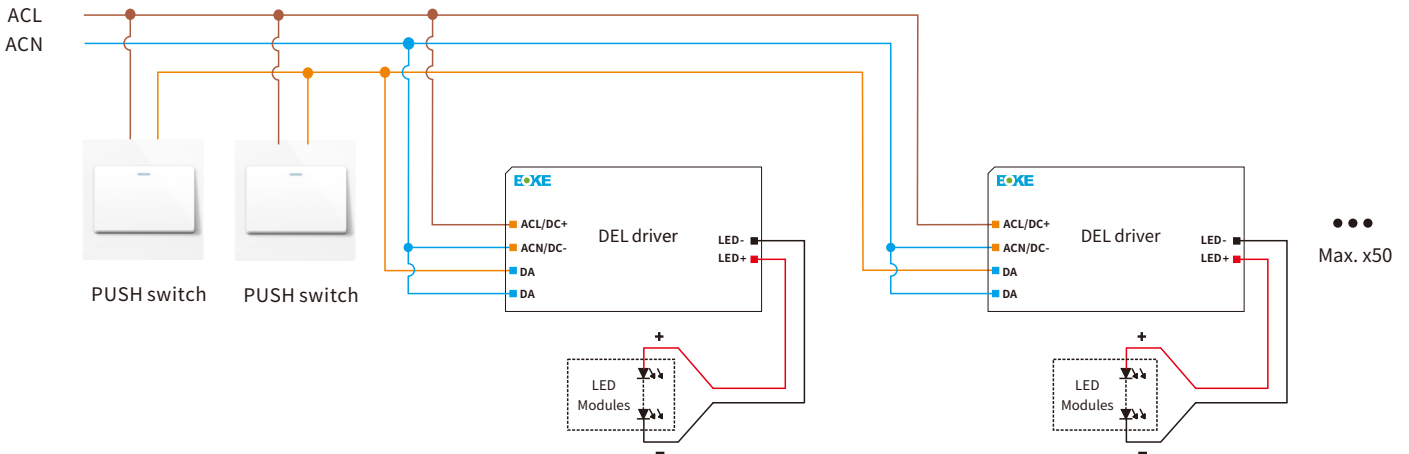

Activating pushDIM dimming mode

After installation according to the wiring diagram of pushDIIM dimming application, short press the pushbutton 3 times within 3 seconds, the driver will automatically switch to pushDIIM dimming mode.

Remarks:

Max. 50 drivers per pushDIM control line.

Turn on or turn off:short press pushbutton for 0.2-1s.

Dimming: long press pushbutton for 1-5s.

Power on status: after power on,the light state will be the same as the lighting on state.

If the light is on before power on,the light will be on after power on again,brightness will be the same as the last lighting on brightness.

If the light is off before power off,the light will be off after power on again,short press the pushbutton,then the light will be on,the brightness will be the same as the last brightness.

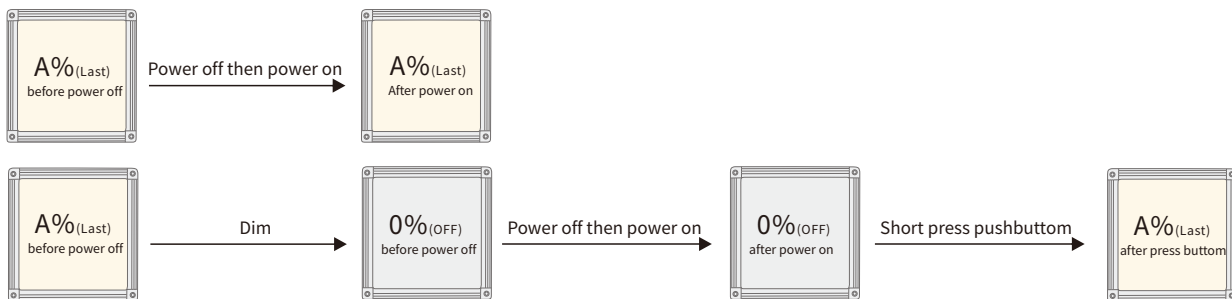

Multiple lights synchronize control operation

method 1:

Step 1:long press the pushbutton,confirm each light is on.

Step 2:short press the pushbutton,confirm each light is off.

Step 3:long press the pushbutton,confirm each light is from darkest to brightest and all the lights are synchronous.

method 2:

- Long press the pushbutton 15s,all lights output to the brightest state.

Installation

Mechanical dimensions

Unit:mm

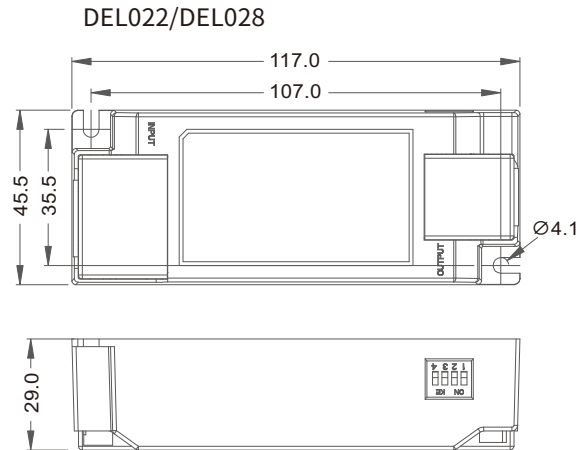
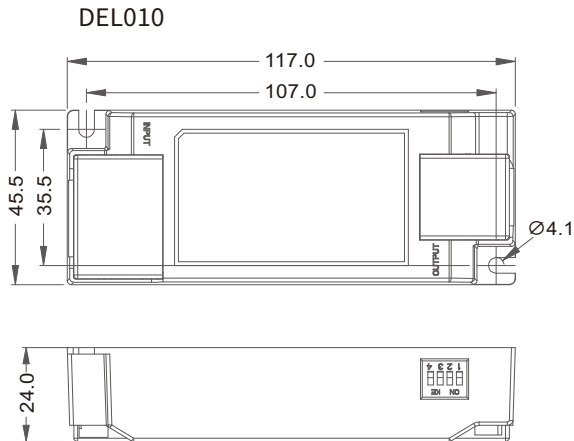

INPUT

Numbering	function	colour
1	ACL/DC+	orange
2	ACN/DC-	orange
3	DA	blue
4	DA	blue

Input wire

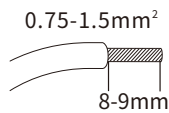

OUTPUT

Numbering	function	colour
1	LED-	black
2	LED+	red

Output wire

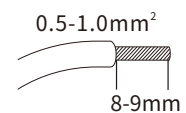

Installation note

Hot plug-in

- Hot plug-in is not supported due to residual output voltage of > 0 V.
- If a LED load is connected the device has to be restarted.
- Restart can be achieved by re-powering the driver or executing a on/off command (action) through the control interface (DALI, pushDIM)

Wiring guidelines

- All connections must be kept as short as possible to ensure good EMI behaviour.
- Mains leads should be kept apart from LED Driver and other leads (ideally 5 - 10 cm distance)
- Max. length of output wires is 2 m.
- Incorrect wiring can damage LED modules.

Mounting screw specifications and torque

- Max. torque at the clamping screw: 0.5 Nm / M4

Replace LED module

1. Mains off
2. Remove LED module
3. Wait for 5 seconds
4. Connect LED module again

Packaging

Optional 1: factory default

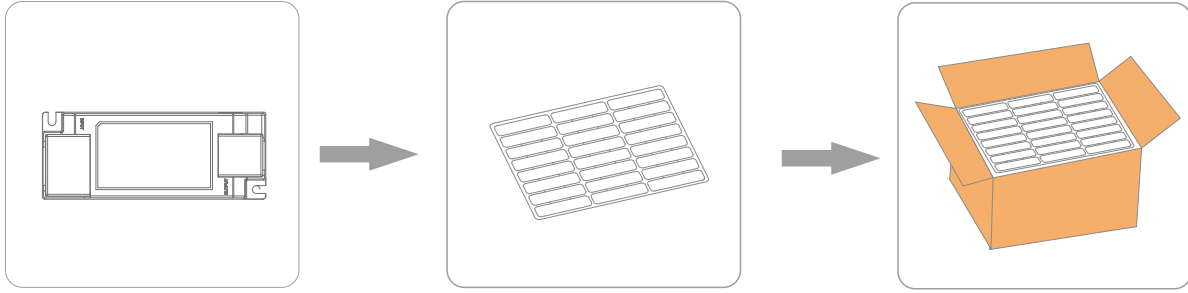

Product

Blister

24pcs×3layer=72pcs/CIN
24pcs×2layer=48pcs/CIN

Model	Product size	Weight	Blister size	Carton size	Qty/carton	N.W	G.W
DEL010	L117*W45.5*H24mm	83g	L430*W340*H47mm	L450*W350*H180mm	72pcs	5.98kg	7.00kg
DEL022	L117*W45.5*H29mm	104g	L430*W340*H47mm	L450*W350*H180mm	72pcs	7.49kg	8.50kg
DEL028	L117*W45.5*H29mm	165g	L430*W340*H47mm	L450*W350*H130mm	48pcs	7.92kg	8.93kg

Optional 2:

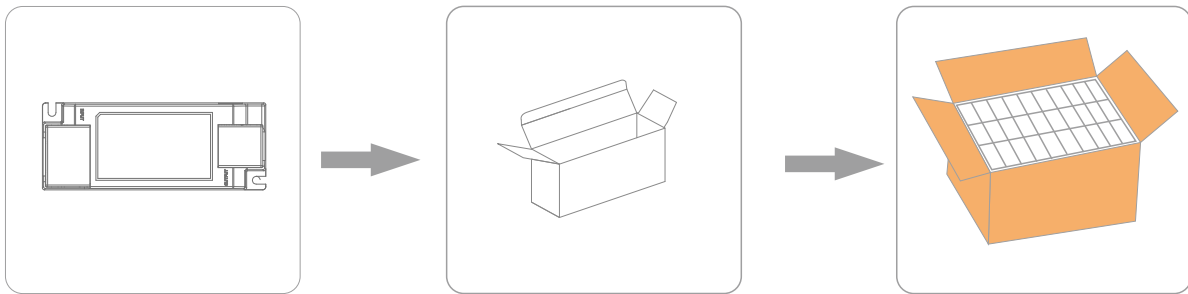

Product

Packaging

18pcs×3layer=54pcs/CIN

Model	Product size	Weight	Packaging size	Carton size	Qty/carton	N.W	G.W
DEL010	L117*W45.5*H24mm	84g	L140*W35*H50mm	L345*W310*H170mm	54pcs	4.54kg	6.10kg
DEL022	L117*W45.5*H29mm	104g	L140*W35*H50mm	L345*W310*H170mm	54pcs	5.62kg	7.18kg
DEL028	L117*W45.5*H29mm	165g	L140*W35*H50mm	L345*W310*H170mm	54pcs	8.91kg	10.5kg

Additional information

1. This product can only be used outside the light body, Can not be used inside of the light, and it must be used within the specified working environment.
2. The life and MTBF of the product are for reference only, and do not represent a warranty statement. If the drive has been turned on, there is no warranty.
3. For more information, please send an email to info@bokedriver.com.